



## Highlights

- Affordable productivity gains. Check out our Multi-Display Payback Calculator—determine the cost benefit associated with adding a second display
- Positions screens for maximum ergonomic comfort
- Extends LCDs or laptop up to 25" (64 cm) with an adjustment range of 18" (45,7 cm); push your displays out of the way when not in use
- Frees up the desktop to increase workspace
- Easy to use: simple installation and effortless operation

# Ergotron® LX

## Dual Stacking Arm



Durable polished aluminum construction!

Make the most of your valuable workspace with Ergotron's LX Desk Mount Arms. Lifting your notebook computer and/or display off the desktop reclaims workspace and positions the screen to relieve eye, neck and back strain.

- Versatile: use with a notebook and LCD or with two LCDs
- Effortlessly lift your notebook to eye level and free up your workspace
- Use notebook with or without docking station



Typical LCD Size	Weight Capacity*	Lift	Tilt	Pan	Rotation	VESA
≤ 24"	40 lbs 18,1 kg	13" 33 cm	85°	360°	360° P/L	MIS-D

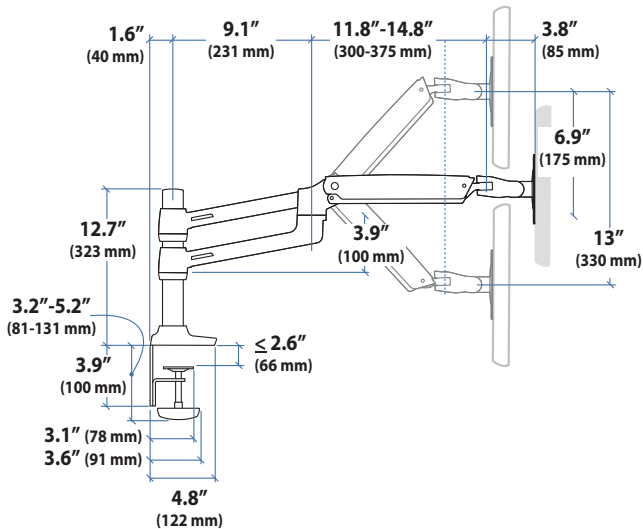

Product Name	LX Dual Stacking Arm
Part Number	45-248-026 (polished aluminum)
Product Includes	Two (2) LCD arms and extensions, pole, desk clamp and grommet mount, one (1) notebook tray, notebook fastening kit (you choose: Velcro, non-slip pad or clips)
Attachment Options	Desk clamp attaches to edge up to 2.6" (66 mm) thick; grommet mount attaches through hole 5/16"-2" (7-51 mm) wide and up to 3" (80 mm) thick
Shipping Dimensions	19.25" x 15.25" x 9" (487 x 387 x 229 mm)
Shipping Weight	15.75 lbs (7,18 kg)
Warranty	5 years
Weight Capacity	*Maximum individual LCD weight 7-20 lbs (3,1- 9,1 kg); notebook weight range 2.5-12 lbs (1,1-5,4 kg); maximum combined weight 40 lbs (18,1 kg)
Compatible Display(s)	VESA FDMI MIS-D, 100/75, C (hole pattern: 100 x 100 mm & 75 x 75 mm)

© 2010 Ergotron, Inc. rev. 03/01/2010 e-05-062 Content is subject to change without notification.

**Americas Sales and Corporate Headquarters**

St. Paul, MN USA  
(800) 888-8458  
+1-651-681-7600  
www.ergotron.com  
sales@ergotron.com

**EMEA Sales**

Amersfoort, The Netherlands  
+31 33 45 45 600  
www.ergotron.com  
info.eu@ergotron.com

**APAC Sales**

Tokyo, Japan  
www.ergotron.com  
apaccustomerservice@ergotron.com

**Worldwide OEM Sales**

www.ergotron.com  
info.oem@ergotron.com

